

# **KTV/KTVE/NK Series**

## **Submersible Dewatering Pump**

# **OPERATION MANUAL**

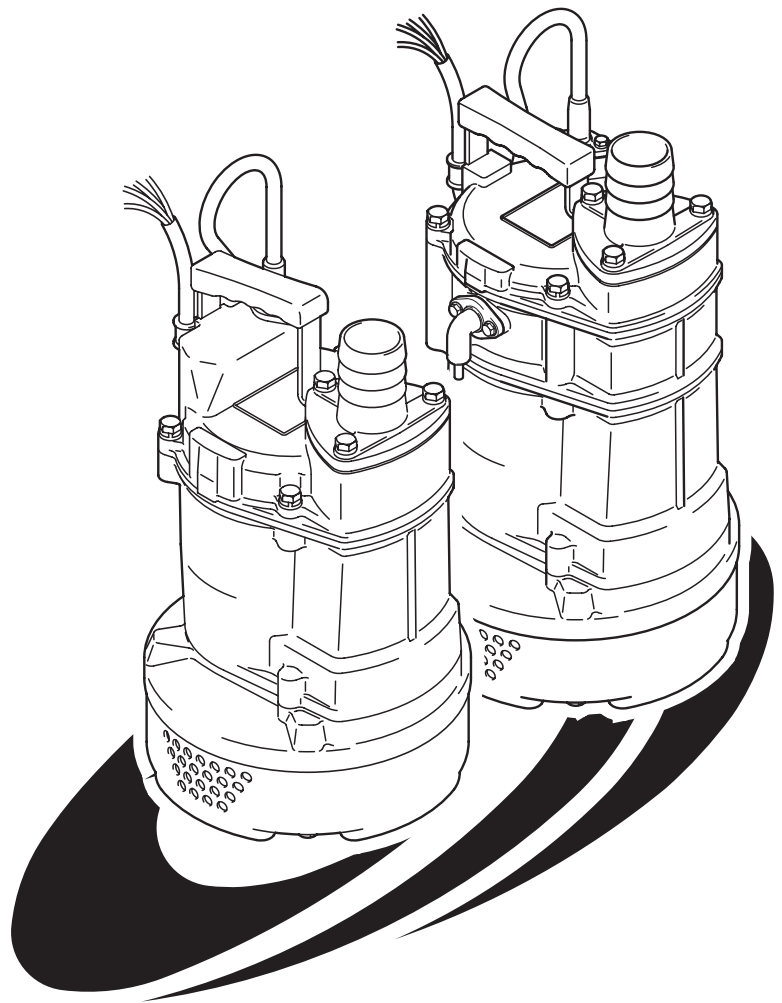

**TSURUMI MANUFACTURING CO., LTD.**

## INTRODUCTION

Thank you for selecting the KTV/KTVE/NK Tsurumi Submersible Dewatering Pump.

This manual explains how to use this equipment and gives instructions on precautions to take during use. In order to understand the features of the product and to use it in the most effective manner, read this manual and understand its contents before using the product.

This equipment should not be used for the applications other than those listed in this manual. Failure to observe this precaution may lead to a malfunction or an accident. In the event of a malfunction or an accident, the manufacturer will not assume any liability. After reading this operation manual, keep it in a location that is easily accessible, so that it can be referred to whenever information is needed.

In case this equipment is lent to another party, be sure to also lend this operation manual together with the equipment.

If this operation manual becomes lost or damaged, contact the dealer where the equipment was purchased, or the Tsurumi sales office in your area.

This manual was prepared with the utmost attention to detail. However, if any errors or omissions are encountered, contact the dealer from whom this unit was purchased, or the Tsurumi sales office in your area.

The content of this manual may not be copied, in whole or part, without consent of Tsurumi Manufacturing Company, Limited.

### CONTENTS

1. BE SURE TO READ FOR YOUR SAFETY .....	2
2. NAME OF PARTS .....	5
3. PRIOR TO OPERATION .....	6
4. INSTALLATION .....	7
5. ELECTRICAL WIRING .....	10
6. OPERATION.....	12
7. MAINTENANCE AND INSPECTION.....	16
8. DISASSEMBLY AND REASSEMBLY PROCEDURE .....	18
9. TROUBLESHOOTING .....	21

# 1 BE SURE TO READ FOR YOUR SAFETY

Be sure to thoroughly read and understand the SAFETY PRECAUTIONS given in this section before using the equipment in order to operate the equipment correctly.

The precautionary measures described in this section are intended to prevent danger or damage to you or to others. The contents of this manual that could possibly be performed improperly are classified into two categories: **⚠ WARNING**, and **⚠ CAUTION**. The categories indicate the extent of possible damage or the urgency of the precaution. Note however, that what is included under **⚠ CAUTION** may at times lead to a more serious problem. In either case, the categories pertain to safety-related items, and as such, must be observed carefully.

- **⚠ WARNING** : Operating the equipment improperly by failing to observe this precaution may possibly lead to death or injury to humans.
- **⚠ CAUTION** : Operating the equipment improperly by failing to observe this precaution may possibly cause injury to humans and other physical damage.
- **NOTE** : Gives information that does not fall in the WARNING or CAUTION categories.
- **Explanation of Symbols:**



: The  $\triangle$  mark indicates a WARNING or CAUTION item. The symbol inside the mark describes the precaution in more detail ("electrical shock", in the case of the example on the left).



: The  $\circ$  mark indicates a prohibited action. The symbol inside the mark, or a notation in the vicinity of the mark describes the precaution in more detail ("disassembly prohibited", in the case of the example on the left).



: The  $\bullet$  mark indicates an action that must be taken, or instructs how to perform a task. The symbol inside the mark describes the precaution in more detail ("provide ground work", in the case of the example on the left).

## PRECAUTIONS TO THE PRODUCT SPECIFICATIONS

### ⚠ CAUTION













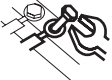
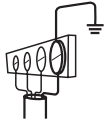



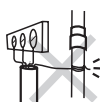





● Do not operate the product under any conditions other than those for which it is specified. **Failure to observe the precaution can lead to electrical leakage, electrical shock, fire, water overflow or other problems.**



















## PRECAUTIONS DURING TRANSPORT AND INSTALLATION



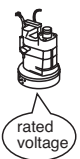

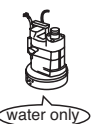

### ⚠ WARNING

	<p>● When transporting the product, pay close attention to its center of gravity and mass. Use an appropriate lifting equipment to lift the unit. <b>Improper lifting may result in the fall of the product which could cause damage of the product or human injury.</b></p> 		<p>● Install the product properly in accordance with this instruction manual. <b>Improper installation may result in electrical leakage, electrical shock, fire, water leakage, or injury.</b></p> 
	<p>● Electrical wiring should be performed in accordance with all applicable regulations in your country. <b>Absolutely provide a dedicated earth leakage circuit breaker and a thermal overload relay suitable for the product (available on the market). Imperfect wiring or improper protective equipment can lead to electrical leakage, fire, or explosion in the worst case.</b></p> 		<p>● Provide a secure grounding dedicated for the product. Never fail to provide an earth leakage circuit breaker and a thermal overload relay in your starter or control panel (Both available on the market). <b>If an electrical leakage occurs by due to a product failure, it may cause electrical shock.</b></p> 





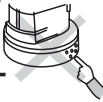





 <b>CAUTION</b>	
 <ul style="list-style-type: none"> <li>● Be sure to provide a ground wire securely. Do not connect the ground wire to a gas pipe, water pipe, lightning rod, or telephone ground wire. <b>Improper grounding could cause electrical shock.</b></li> </ul> 	 <ul style="list-style-type: none"> <li>● Attach a hose securely to the hose coupling. <b>Imperfect connection of hose could cause water leakage which may result in the damage of nearby walls, floors, and other equipment.</b></li> </ul> 
 <ul style="list-style-type: none"> <li>● Do not scratch, fold, twist, make alterations, or bundle the cable, or use it as a lifting device. <b>The cable may be damaged, which may cause electrical leakage, short-circuit, electrical shock, or fire.</b></li> </ul> 	 <ul style="list-style-type: none"> <li>● Do not use the cabtyre cable if it is damaged. Connect every conductor of the cabtyre cable securely to the terminals. <b>Failure to observe this can lead to electrical shock, short-circuit, or fire.</b></li> </ul> 
 <ul style="list-style-type: none"> <li>● When the product will be carried by hand, decide the number of persons considering the mass of the product. When lifting up the product, do not attempt to do it by simply bowing from the waist. <b>Use the knees, too, to protect your back.</b></li> </ul> 	 <ul style="list-style-type: none"> <li>● Use the handle when installing or carrying the pump. Never use the cable to carry or to suspend. <b>Doing so may damage the cable which could cause electrical leakage, short circuit, or fire.</b></li> </ul> 
 <ul style="list-style-type: none"> <li>● This pump is neither dust-proof nor explosion-proof. Do not use it at a dusty place or at a place where toxic, corrosive or explosive gas is present. <b>Use in such places could cause fire or explosion.</b></li> </ul> 	 <ul style="list-style-type: none"> <li>● Allow the pump to suck as few foreign object as possible. If there is a risk that the pump could be buried under the sediment, place it on a solid base like concrete block. <b>Failure to do so may result in breakdown of the pump and could cause electrical leakage or short circuit.</b></li> </ul> 
 <ul style="list-style-type: none"> <li>● If a hose is used for the discharge line, take a measure to prevent the hose from shaking. <b>If the hose shakes, you may be wet or injured.</b></li> </ul> 	

## PRECAUTIONS DURING TEST OPERATION AND OPERATION

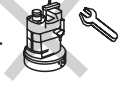

 <b>WARNING</b>	
 <ul style="list-style-type: none"> <li>● Never try to operate the pump if somebody is present in the pump sump. <b>If an electrical leakage occurs, it can cause electrical shock.</b></li> </ul> 	 <ul style="list-style-type: none"> <li>● When changing power connection is needed to correct the direction of rotation, be sure to turn off the power supply (earth leakage circuit breaker, etc.), and perform the work after making sure that the impeller has stopped completely. <b>Failure to do so may lead to electrical shock, short-circuit, or injury.</b></li> </ul> 
 <ul style="list-style-type: none"> <li>● Never start the pump while it is suspended, as <b>the unit may jerk and could lead to injury.</b></li> </ul> 	 <ul style="list-style-type: none"> <li>● When changing power connection is needed to correct the direction of rotation, be sure to turn off the power supply (earth leakage circuit breaker, etc.), and perform the work after making sure that the impeller has stopped completely. <b>Failure to do so may lead to electrical shock, short-circuit, or injury.</b></li> </ul> 
 <b>CAUTION</b>	
 <ul style="list-style-type: none"> <li>● Do not operate the product under any voltage other than described on the nameplate with the voltage tolerance limit within <math>\pm 5\%</math>. If it is operated with a generator, it is strongly suggested not to operate other equipment with the same generator. <b>Failure to observe this caution may cause malfunction and breakdown of the product, which may lead to electrical leakage or electrical shock.</b></li> </ul> 	 <ul style="list-style-type: none"> <li>● Do not touch the product with bare hands during or immediate after the operation, as the product may become very hot during operation. <b>Failure to observe this caution may lead to be burned.</b></li> </ul> 
 <ul style="list-style-type: none"> <li>● Do not use the product in a liquid other than water. <b>Use in oil, salt water or organic solvents will damage it, which may lead to electrical leakage or electrical shock.</b></li> </ul> 	 <ul style="list-style-type: none"> <li>● Do not run the product dry or operate it with its gate valve closed, as <b>doing so will damage the product, which may lead to electrical leakage or electrical shock.</b></li> </ul> 

 <b>CAUTION</b>	
	<ul style="list-style-type: none"> <li>Do not use the product for hot or warm liquid over 40°C, as <b>doing so will damage the product, which may lead to electrical leakage or electrical shock.</b> </li> </ul>
	<ul style="list-style-type: none"> <li>Do not allow foreign object (pin, wire, etc.) to enter the suction inlet of the pump. <b>Failure to observe this caution could cause it to malfunction or to operate abnormally, which may lead to electrical leakage or electrical shock.</b> </li> </ul>
	<ul style="list-style-type: none"> <li>When the product will not be used for an extended period, be sure to turn off the power supply (earth leakage circuit breaker, etc.). <b>Deterioration of the insulation may lead to electrical leakage, electrical shock, or fire.</b> </li> </ul>



## PRECAUTIONS DURING MAINTENANCE AND INSPECTION

 <b>WARNING</b>	
	<ul style="list-style-type: none"> <li>Absolutely turn off the power supply or disconnect the plug before starting maintenance or inspection. Do not work with wet hands. <b>Failure to observe these cautions may lead to electrical shock or injury.</b> </li> </ul>
	<ul style="list-style-type: none"> <li>In case any abnormality (excessive vibration, unusual noise or odor) is found in the operation, turn the power off immediately and consult with the dealer where it was purchased or Tsurumi representative. <b>Continuing to operate the product under abnormal conditions may result in electrical shock, fire, or water leakage.</b> </li> </ul>
	<ul style="list-style-type: none"> <li>Do not disassemble or repair any parts other than those designated in the operation manual. If repairs are necessary in any other than the designated parts, consult with the dealer where it was purchased or Tsurumi representative. <b>Improper repairs can result in electrical leakage, electrical shock, fire, or water leakage.</b> </li> </ul>
 <b>CAUTION</b>	
	<ul style="list-style-type: none"> <li>After reassembly, always perform a test operation before resuming use of the product. <b>Improper assembly can result in electrical leakage, electrical shock, fire, or water leakage.</b> </li> </ul>

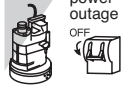
## PRECAUTION TO POWER OUTAGE

 <b>WARNING</b>	
	<ul style="list-style-type: none"> <li>In case of power outage, turn off the power supply. <b>The product will resume operation when the power is restored, which presents serious danger to people in the vicinity.</b> </li> </ul>

## OTHER PRECAUTION

 <b>CAUTION</b>	
	<ul style="list-style-type: none"> <li>Never use the product for potable water. <b>It may present a danger to human health.</b> </li> </ul>

## 2 NAME OF PARTS

### ■ Example ; KTV Series

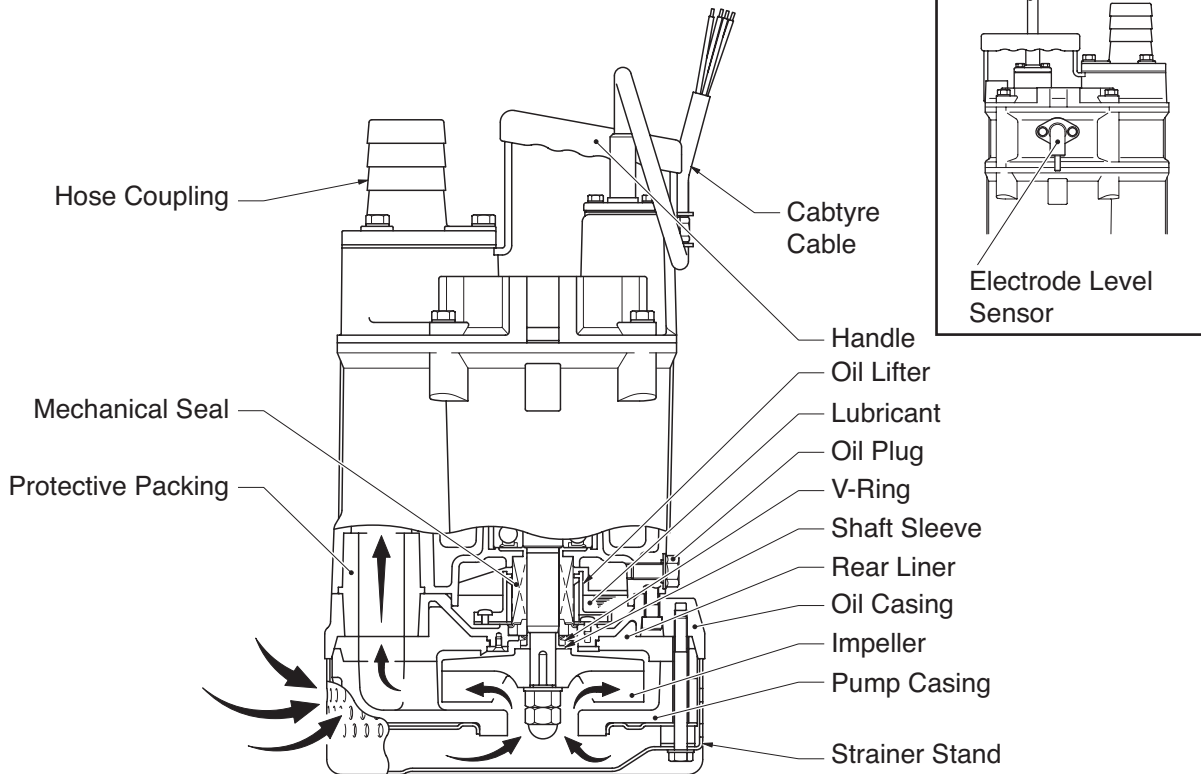

**Note:** The above diagram is typical of the KTV2-22, but some models may vary slightly in appearance or internal structure.

### ■ Example ; NK Series

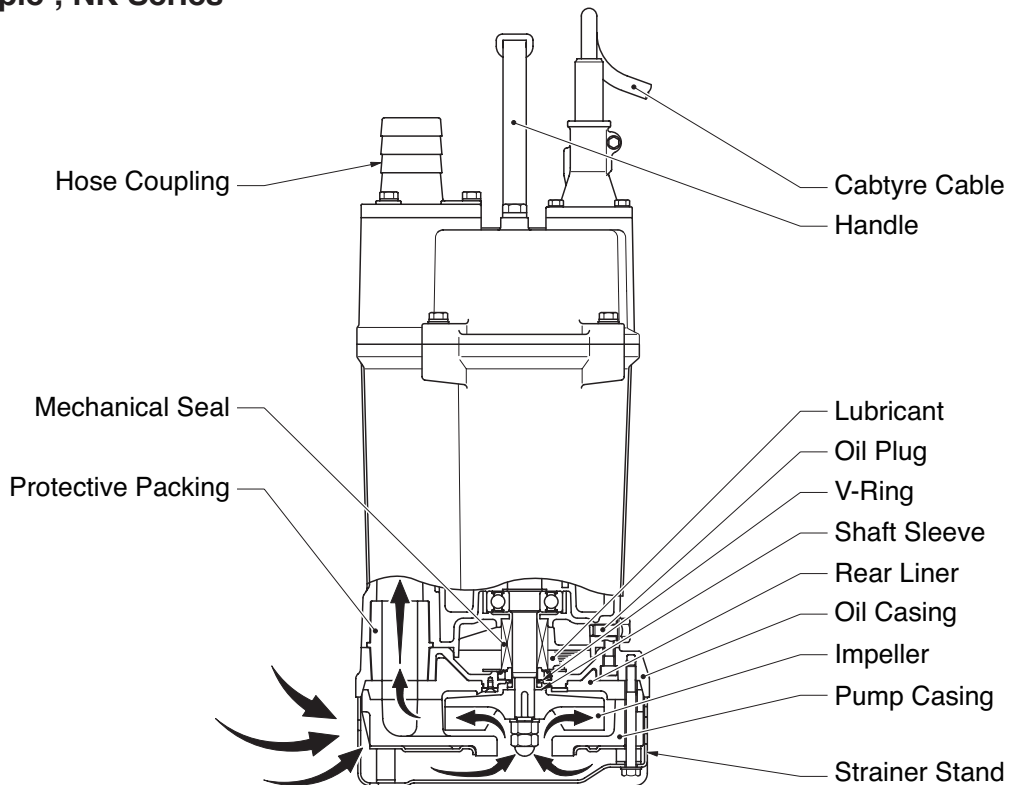

**Note:** The above diagram is typical of the NK2-22, but some models may vary slightly in appearance or internal structure.

### 3 PRIOR TO OPERATION

When the pump is delivered, first perform the following checks.

#### Inspection

While unpacking, inspect the product for damage during shipment, and make sure all bolts and nuts are tightened properly.

#### Specification Check

Check the nameplate of the pump unit to verify that it is the product that you have ordered. Pay particular attention to its voltage and frequency specifications.

#### Example of nameplate

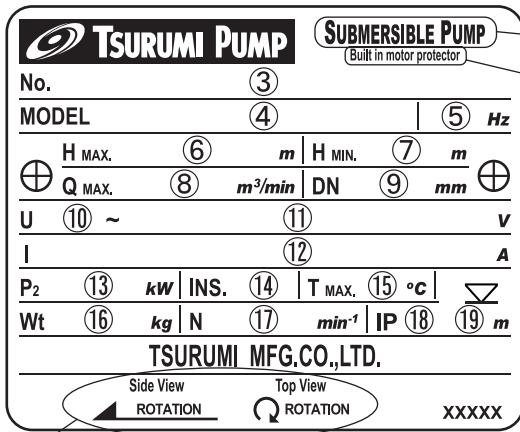

1	Submersible pump	11	Rated voltage
2	Built in motor protector	12	Rated current
3	Serial number	13	Rated output power
4	Model	14	Insulation class
5	Frequency	15	Max. liquid temperature
6	Max. total head	16	Weight without cable
7	Min. total head	17	Speed of rotation
8	Max. flow rate	18	IP degree of protection
9	Discharge bore	19	Max. immersion depth
10	Phase	20	Direction of rotation

**Note:** If there is any problem with the product as shipped, contact your nearest dealer or Tsurumi representative at once.

#### Accessory Check

Verify that all accessory items are included in the package.

- Hose Band (0.75kW) ..... 1 pc
- Operation Manual ..... 1

**Note:** If you discover any damage or discrepancy in the product, please contact the dealer where this equipment was purchased or the Tsurumi sales office in your area.

#### Product Specifications

**CAUTION** Do not operate this product under any conditions other than those for which it is specified. Failure to observe this precaution can lead to electrical shock, electrical leakage, fire, water leakage or other problems.

#### Major Standard Specifications

Applicable Liquids	Property	Rain water, Ground water, Sand carrying water ; 0 ~ 40°C
Pump	Impeller	Semi-vortex Type
	Shaft Seal	Double Mechanical Seal
	Bearing	Shielded Ball Bearing
Motor	Specification	Dry Type Submersible Induction Motor, 2-pole
	Insulation	Class E (KTV/KTVE Series), Class B, F (NK Series)
	Protection System (Built-in)	Circle Thermal Protector
	Lubricant	Turbine oil VG32 (non-additive)
Discharge Connection		Hose Coupling

## ■ Specifications - Non-Automatic Pumps (50/60Hz)

Model	Discharge Bore (mm) (inch)	Phase	Starting Method	Output (kW)	Max. Total Head (m) (feet)	Max. Flow Rate (m <sup>3</sup> /min) (GPM)	Weight (kg)
KTV2-8	50	3	Direct-on-Line	0.75	15.0/16.0	0.32	11.5
	2				- /52.5	85	
KTV2-15	50	3	Direct-on-Line	1.5	20.0/21.0	0.42	21
	2				- /69	111	
KTV2-22	50	3	Direct-on-Line	2.2	24.0/26.0	0.52/0.495	23.0
	2				- /85	- /131	
KTV2-37H	50	3	Direct-on-Line	3.7	33.8/35.0	0.50/0.48	36
	2				- /115	- /127	
KTV2-37	80	3	Direct-on-Line	3.7	26.5/28.5	0.83/0.82	36
	3				- /94	- /217	
KTV3-55 *	80	3	Direct-on-Line	5.5	35.0/37.0	0.98/0.87	47
	3				- /121	- /230	
NK3-15	50(80)	1	Capacitor-Start	1.5	20.0/21.0	0.42	29
	2(3)				- /69	111	
NK4-22	50(80)	1	Capacitor-Start Capacitor-Run	2.2	24.0/26.0	0.525/0.495	29
	2(3)				- /85	- /131	
NK3-22L	80	1	Capacitor-Start Capacitor-Run	2.2	18/18	0.8/0.8	40
	3				- /59	- /211	

\* USA market: KTV2-55

**Note:** The weight (mass) given above is the operating weight of the pump itself, not including the cable.

## ■ Specifications - Automatic Pumps (50/60Hz)

Model	Discharge Bore (mm) (inch)	Phase	Starting Method	Output (kW)	Max. Total Head (m) (feet)	Max. Flow Rate (m <sup>3</sup> /min) (GPM)	Weight (kg)
KTVE2.75	50	3	Direct-on-Line	0.75	15.0/16.0	0.32	12.7
	2				- /52.5	85	
KTVE21.5	50	3	Direct-on-Line	1.5	20.0/21.0	0.42	22
	2				- /69	111	
KTVE22.2	50	3	Direct-on-Line	2.2	24.0/26.0	0.52/0.495	25
	2				- /85	- /131	
KTVE33.7	80	3	Direct-on-Line	3.7	26.5/28.5	0.83/0.82	40
	3				- /94	- /217	
KTVE35.5	80	3	Direct-on-Line	5.5	35.0/37.0	0.98/0.87	52
	3				- /121	- /230	

**Note:** The weight (mass) given above is the operating weight of the pump itself, not including the cable.

## 4 INSTALLATION

### ⚠ CAUTION

- Do not use this pump in liquids other than water, such as oil, salt water, or organic solvents.
- Use with a power supply voltage tolerance within  $\pm 5\%$  of the rated voltage.
- Do not use in water temperatures outside the range of 0 ~ 40°C, which can lead to failure, electrical leakage or shock.
- Do not use in the vicinity of explosive or flammable materials.
- Use only in fully assembled state.

**Note:** Consult your local dealer or Tsurumi representative before using with any liquids other than those indicated in this document.

### Maximum allowable water pressure

### ⚠ CAUTION

Do not use at greater than the water pressure shown below, which can damage the pump resulting in electrical leakage and electrical shock.

Model	Maximum allowable water pressure
KTV2-8	0.2 MPa (2 kgf/cm <sup>2</sup> ) - discharge pressure used
All other models	0.5 MPa (5 kgf/cm <sup>2</sup> ) - discharge pressure used



## Preparing for installation

Before installing the pump at a work site, you will need to have the following tools and instruments ready:

- Insulation resistance tester
- AC voltmeter
- AC ammeter (clamp-on type)
- Bolt and nut tighteners
- Power supply connection tools (screwdriver or box wrench)

**Note:** Please read also the instructions that come with each of the test instruments.

## Checks to make before installation

Use the megohmmeter to measure the motor insulation resistance between the cabtyre cable plug tips and ground lead (Green or Green/Yellow).

■ Insulation resistance reference value =  $20M\Omega$  min.

**Note:** The insulation reference value of  $20M\Omega$  min. is based on a new or repaired pump. For reference value of a pump that has already been installed, refer to "7. Maintenance and Inspection" on page 16 of this manual.

## Automatic Pumps

Bundle each core of the cabtyre cable (Red, White and Black, or Brown, Grey and Black), then measure and check the insulation resistance between the ground wire (Green or Green/Yellow) with an insulation resistance tester.

**Note:** In case of measuring between each core of the cabtyre cable and ground wire, it may not measure correctly because of the characteristic.

■ Insulation resistance reference value =  $20M\Omega$  or more

**Note:** The insulation reference value of  $20M\Omega$  min. is based on a new or repaired pump. For reference value of a pump that has already been installed, refer to "7. Maintenance and Inspection" on page 16 of this manual.

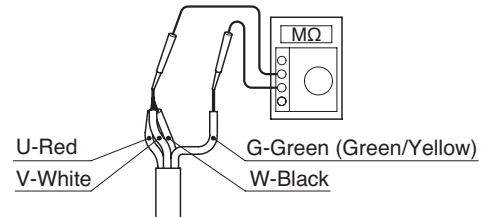

**CAUTION** Do not measure the insulation resistance with an insulation resistance tester for following parts. It may cause control circuit troubles.

(1) Between the electrode and the pump body

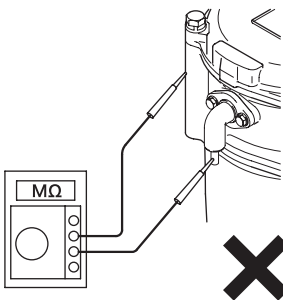

(2) Between the electrode and each lead wire

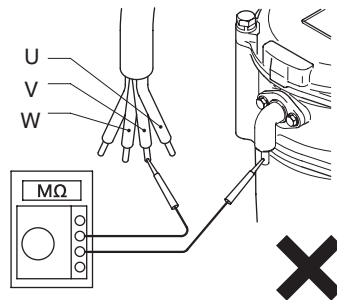

**CAUTION** Do not lift or suspend by the electrode level sensor. It may cause current leakage, electrical shock or fire.

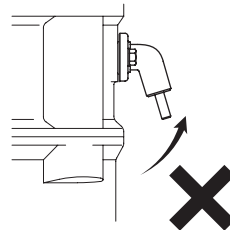

## Precautions in installation



### WARNING

- When installing the pump, pay close attention to its center of gravity and weight. If it is not lowered into place correctly, it may fall and be damaged or cause injury.
- When transporting the pump by hand, be sure to employ manpower commensurate with the weight of the pump. To avoid back injury when lifting the pump, bend the knees to pick it up rather than bending your back only.



### CAUTION

Do not under any circumstances install or move the pump by suspending it from the cabtyre cable. The cable may be damaged, causing electrical leakage, shock, or fire.

- (1) Attach the hose to the hose coupling as far as it will go, then fasten it securely with the hose band.

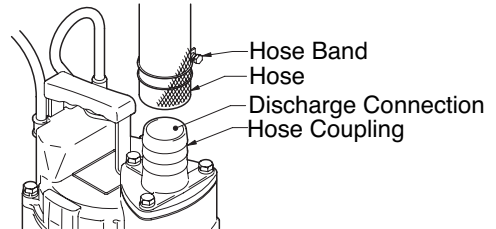

- (2) Avoid dropping the pump or other strong impact. Lift the pump by holding it firmly with the hands or by attaching a rope or chain to the handle.

**Note:** On Cabtyre cable handling, see below *Electrical Wiring*.

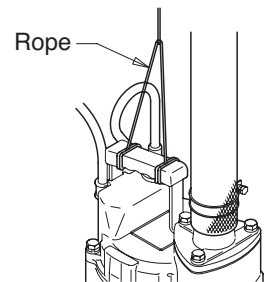

- (3) Install the pump in a location with sufficient water level, where water collects readily.

**Note:** The "Operating water level" chart on page 13 shows the water level necessary for operation. The tip of the hose (discharge end) should be located higher than the water surface. If the end of the hose is submerged, water may flow back to the pump when the pump is stopped; and if the hose end is lower than the water surface, water may overflow when the pump is turned off.

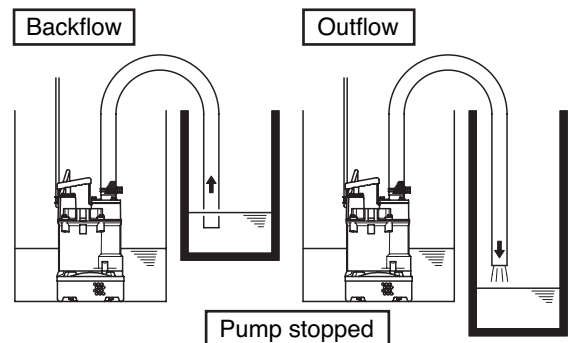

- (4) The hose should be run as straight as possible, since excessive bending will hinder the water flow, preventing sufficient lift, and can even cause the hose to become clogged with earth. If the hose is crimped near the pump, air can become trapped in the pump and cause idle running.



### CAUTION

- If large quantities of earth are sucked up, damage resulting from abrasion in the pump can lead to electrical leakage and shock.
- When the pump is installed at a work site, make sure the hose is connected in such a way as to ensure proper drainage. Otherwise water may leak out and cause damage to surrounding walls or flooring, or to equipment.

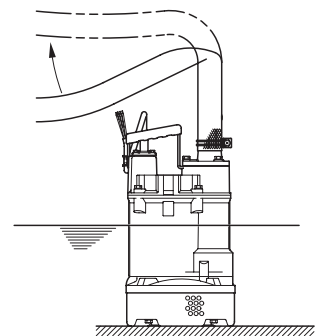

- (5) Use the pump in the upright position. To prevent the pump from becoming submerged in mud, mount it on a block or other firm base if necessary.



### CAUTION

Pay attention that the electrode level sensor shall not be splashed. It may cause a malfunction.

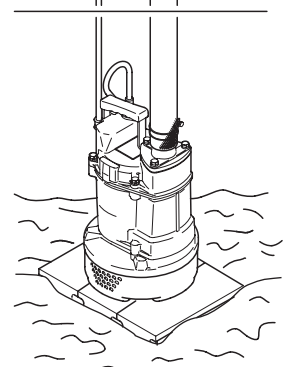

# 5 ELECTRICAL WIRING

## Performing electrical wiring



### WARNING

- Electrical wiring should be performed by a qualified person in accord with all applicable local regulations. Failure to observe this precaution not only risks breaking the law but is extremely dangerous.
- Incorrect wiring can lead to electrical leakage, electrical shock or fire.
- Absolutely provide a dedicated earth leakage circuit breaker and a thermal overload relay suitable for the pump (available on the market). Failure to follow this warning can cause electrical shock or explosion when the product fails or an electrical leakage occurs.

Operate well within the capacity of the power supply and wiring.

## Grounding



### WARNING

Do not use the pump without first grounding it properly. Failure to ground it can lead to electrical shock from an electrical leak or pump malfunction.



### CAUTION

Do not attach the grounding wire to a gas pipe, water pipe, lightning arrestor or telephone grounding wire. Improper grounding can result in electrical shock.

## Cabtyre cable



### CAUTION

- If it is necessary to extend the cabtyre cable, use a core size equal to or larger than the original. This is necessary not only for avoiding a performance drop, but to prevent cable overheating which can result in fire, electrical leakage or electrical shock.
- If a cable with cut insulation or other damage is submerged in the water, there is a danger of water seeping into the motor causing a short. This may result in damage to the pump, electrical leakage, electrical shock, or fire.
- Be careful not to let the cabtyre cable be cut or become twisted. This may result in damage to the pump, electrical leakage, electrical shock, or fire.
- If it is necessary to submerge the connection leads of the cabtyre cable in water, first seal the leads completely in a molded protective sleeve, to prevent electrical leakage, electrical shock, or fire.

Do not allow the cabtyre cable leads to become wet.

Make sure the cable does not become excessively bent or twisted, and does not rub against a structure in a way that might damage it.

## Connecting the cabtyre cable



### WARNING

Before connecting leads to the terminals, make certain the power supply is turned off (circuit breaker, etc.), to avoid electrical shock, shorting, or unexpected starting of the pump, leading to injury.



### CAUTION

Do not use the pump if the cabtyre cable is worn or damaged, which can result in electric shock, shorting, or fire.

Connect the leads of cabtyre cable to the control panel terminals as shown in the diagram, being careful not to let the leads become twisted together.

Single-phase models

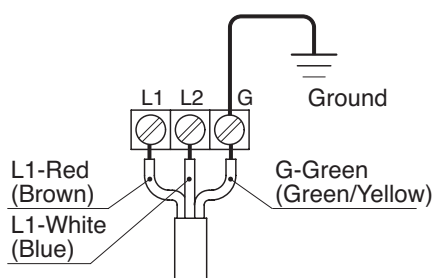

Three-phase models

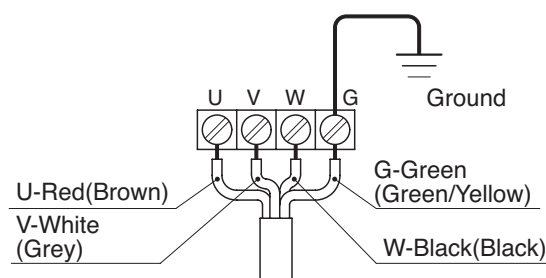

# Electrical circuit diagrams

Direct on line

KTV models

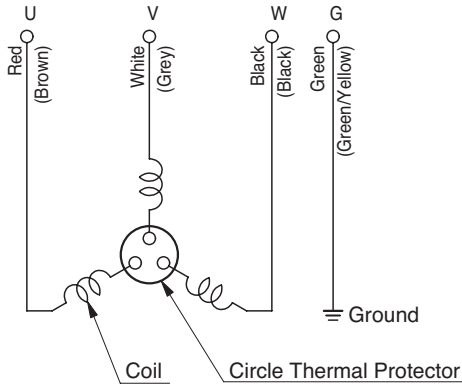

KTVE  
0.75kW models

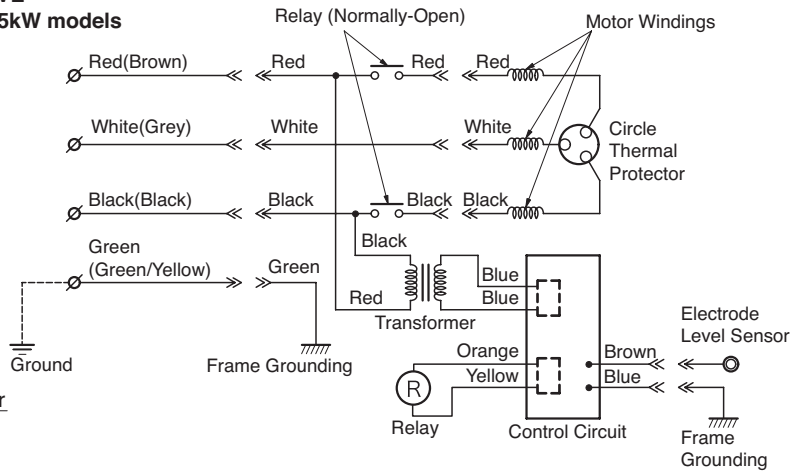

KTVE  
1.5~5.5kW models

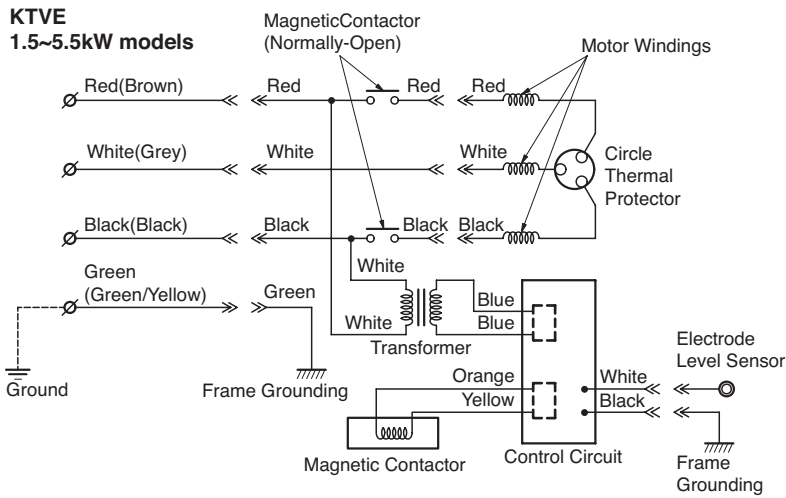

NK3-15 Capacitor-Start models, Single-phase motor  
(110V-50/60Hz)

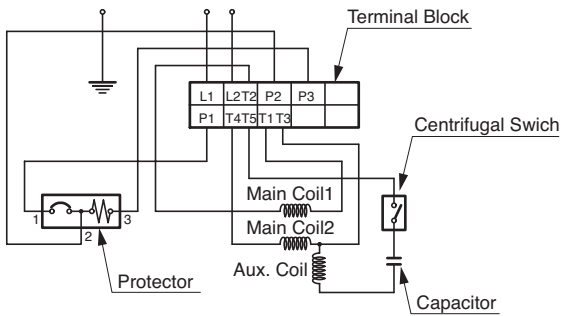

NK3-15 Capacitor-Start models, Single-phase motor  
(220V-50/60Hz)

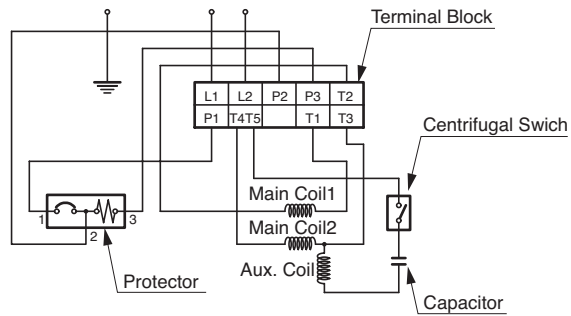

NK3-15 Capacitor-Start models, Single-phase motor  
(220/230/240V-50Hz)

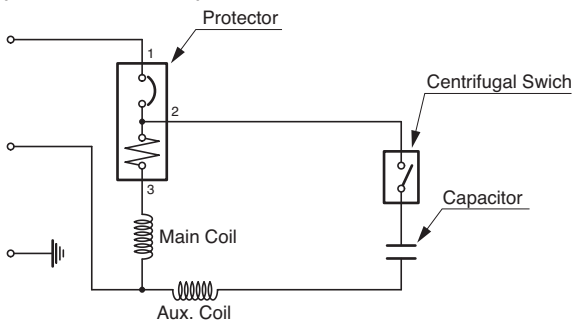

NK4-22/NK3-22L Capacitor-Start and Capacitor-Run models,  
Single-phase motor

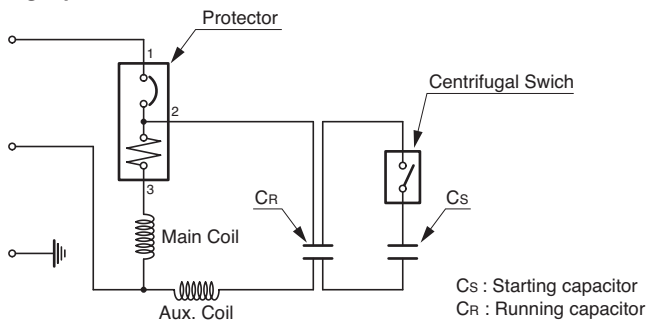

# 6 OPERATION

## Before starting

- (1) Make sure once again that the product is of the correct voltage and frequency rating.

**CAUTION** Using the product at other than rated voltage and frequency will not only lower its performance but may damage the product.

**Note:** Confirm the rated voltage and frequency on the model name plate.

- (2) Confirm the wiring, supply voltage, circuit breaker capacity, and motor insulation resistance.

Reference insulation resistance = 20 MΩ or greater

**Note:** The reference insulation resistance (20MΩ or greater) is the value when the pump is new or has been repaired. For the reference value after installation, see below at section "7.Maintenance and Inspection "

- (3) The setting on the circuit breaker or other overload protector should be made in accord with the rated current of the pump.

**Note:** See the model name plate on the pump for its rated current.

- (4) When powering the pump with a generator, do not share the generator with other equipment.

## Test operation

**WARNING**

- Never operate the pump while it is suspended in the air. The recoil may result in injury or other major accident.
- Never start the pump when people are standing next to it. An electrical leak can result in electrical shock.

- (1) Run the pump for a short time(1~2 seconds) to check the direction of rotation. The rotation is correct if the pump recoil direction is counter-clockwise.

**CAUTION** Always perform the rotation check in air, not while the pump is submersed. Running the pump in reverse direction while submersed may damage the pump, resulting in electrical leakage or electrical shock.

- (2) If the direction is reversed, correct it using the countermeasure shown below.

**WARNING** Before changing the connections to correct the rotation, be sure to turn off the power supply (circuit breaker), and make sure the impeller has stopped completely, to avoid electrical shock or shorting.

### COUNTERMEASURE

(Direct-on-line start models):  
Interchange connections between any two of the three leads U, V, or W.

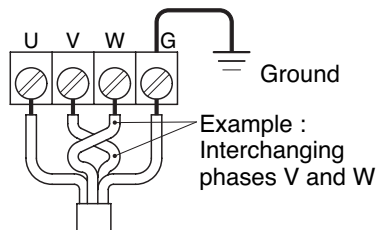

### COUNTERMEASURE

(Star-delta start models):  
Interchange connections between any two of the three leads R, S, or T.

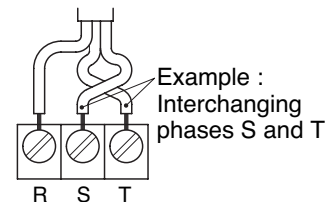

- (3) Run the pump for a short time (3~10minutes) and confirm the following.  
Using an ammeter(clamp-on type), measure the operating current at the U, V, and W phase leads on the terminal strip.

**COUNTERMEASURE**

If the operating current exceeds the rated value, pump motor overload may be a cause. Make sure the pump has been installed under proper conditions as described in the section on Installation.

Using an AC voltmeter(tester), measure voltage at the terminal strip.

■ Supply voltage tolerance : within  $\pm 5\%$  of rated voltage.

**COUNTERMEASURE**

If the supply voltage is outside the variation, possible causes are the power supply capacity or an inadequate extension cable. Look again at Electrical Wiring and make sure the conditions are proper.



**CAUTION**

**In case of very excessive vibration, unusual noise or odor, turn off the power immediately and consult with your nearest dealer or Tsurumi representative. Continuing to operate the pump under abnormal conditions may result in electrical shock, fire, or electrical leakage.**

- (4) If the test operation turns up no problems, continue with full operation.

**Operation**



**WARNING**

- The pump may become very hot during operation. Be careful not to contact the pump accidentally to avoid being burned.
- To avoid serious injury, do not insert a finger or any other object in the pump inlet holes.
- When the pump is not used for an extended period, be sure to turn off the power (circuit breaker, etc.). Deterioration of the insulation may lead to electrical leakage, electrical shock, or fire.
- In case of a power outage, turn off the power to the pump to avoid having it start unexpectedly when the power is restored, presenting serious danger to people in the vicinity.

Pay careful attention to the water level while the pump is operating. Dry operation may cause the pump to malfunction.

**Note:** See below, "Operating water level" for the water level necessary for operation.

**Operation water level**



**CAUTION**

**Do not operate the pump below the C.W.L. (Continuous Running Water Level). Failure to observe this condition may result in damage to the pump, electrical leakage or electrical shock.**

The table shows the C.W.L. for different output classes. Be careful not to allow the water level to drop below the applicable limit.

Applicable Model	C.W.L. (mm)
KTV2-8	65
KTV2-15	80
KTV2-22	80
KTV2-37H	90
KTV2-37	90
KTV3-55 *	90
NK3-15	80
NK4-22	80
NK3-22L	120

\* USA market: KTV2-55

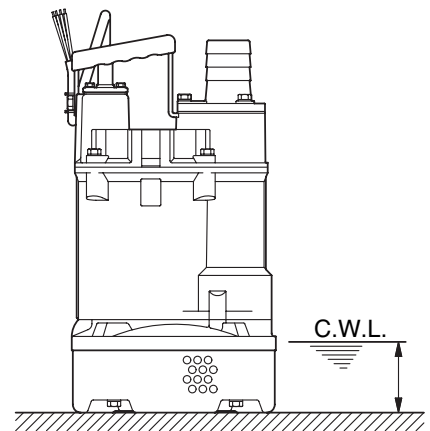

## ■ In the Case of Automatic Pumps

### ■ Starting of a pump

The pump starts when the current (micro current) continuously flows between a conductive part (Shaft, Bolt, etc.) and the electrode level sensor for more than one (1) second.

**Note:** *The electrode may not detect the water surface under conditions such as purified water or distilled water with which the current does not flow because of high specific resistance.*

### ■ Starting Water Level

The water level is decided by the distance between the tip of the electrode level sensor and the sump bottom. If you want to set the starting water level lower, please set as following instruction.

- (1) Fit an extension electrode (optional accessory) to the Electrode Level Sensor of the pump. (The extension electrode is available as an optional accessory.)
- (2) The water level is the distance between the sump bottom and the end.
- (3) Please adjust the water level to the lowest starting level or upper.

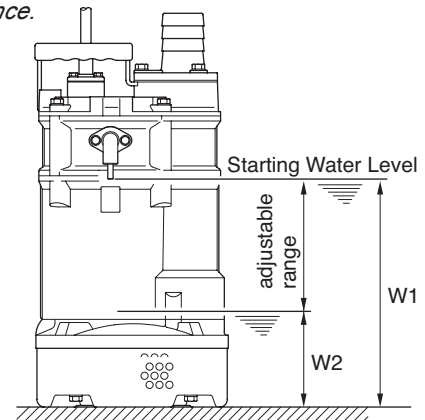

**Note:**

- If you set the water level lower than the lowest starting level, it may not operate correctly because of an air lock and so on.
- Extension Electrode should not touch the pump body.
- In case of starting the unit under non-submerged condition during a trial operation, please short-circuit for more than one (1) second the electrode and the conductive part (bolt, etc.) with a conductive item (lead wire, etc.), and start forcibly.
- You will not get an electric shock if you touch the electrode during power on, however it may cause a wrong operation.

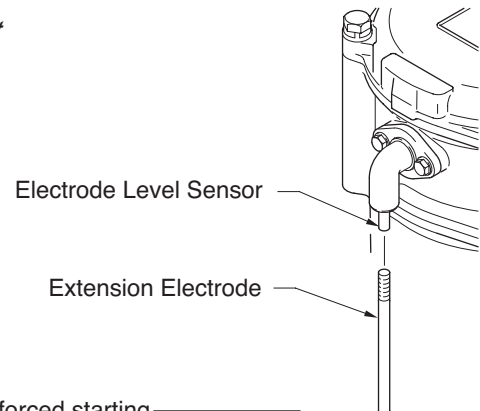

Unit : mm

Pump Model	W1	W2
KTVE2.75	234	144
KTVE21.5	266	176
KTVE22.2	266	176
KTVE33.7	327	237
KTVE35.5	357	267

W1 : Starting Water Level  
(Default setting value)

W2 : The Lowest Starting Level  
(Continuous Running Water Level)  
in case of using an Extension Stick

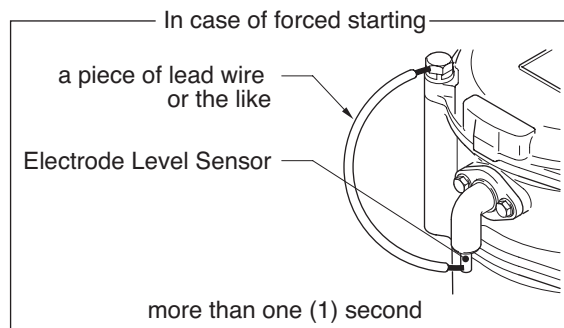

## ■ Motor protection system



### WARNING

During inspections or repairs, always be sure to turn off the power. Sudden unexpected starting of the pump can cause electrical shock, shorting, or serious injury.



### CAUTION

- Always determine the cause of the problem and resolve it before resuming operation. Simply repeating cycles of stopping and restarting will end up damaging the pump.
- Do not continue operation at very low water level, or while the strainer stand is clogged with debris. Not only will performance suffer, but such conditions may cause noise, heavy vibration, and malfunctioning.

### Circle Thermal Protector

If an excessive current is detected or the motor overheats, for reasons such as the following, the pump will automatically stop operating regardless of the water level, to protect the motor.

- Change in supply voltage polarity
- Overload
- Open-phase operation or operation under constraint

## Operating Principle of the Automatic Pumps

This explains the control form by a combination of an electrode and a timer function. Please understand the performance of this pump and apply it.

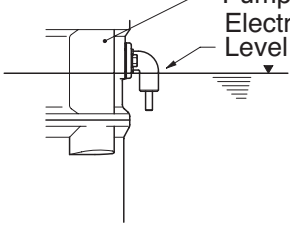
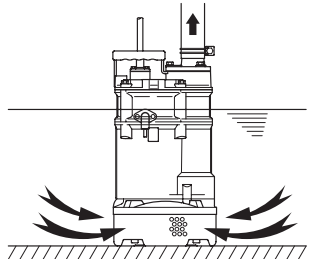
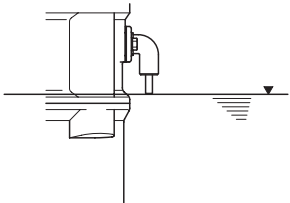
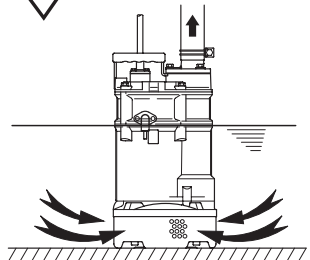
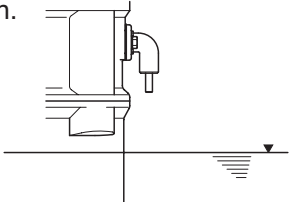
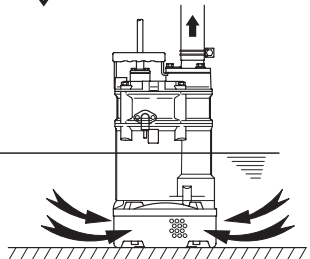
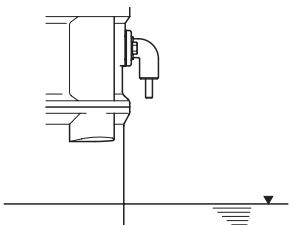
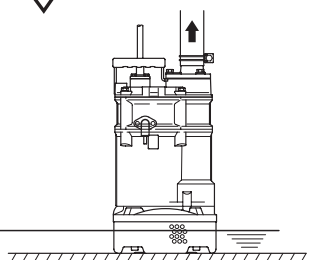
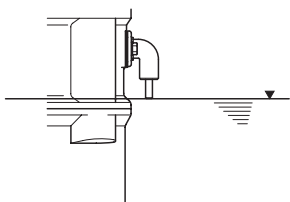
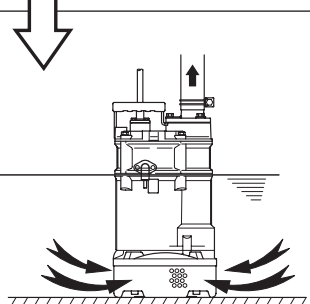
Electrode Level Sensor	Pump	Water Level	Condition
<p>Electrode level sensor will submerge and the pump will operate by the current.</p>  <p>(Detection Time : more than one (1) second)</p>	Start operation (Drainage)	Drop	<p>[Switch on]</p> 
<p>When the water level drops and detaches the electrode from the water surface, a timer will start. Pump keeps draining.</p>  <p>(Released the Electrode → The timer is on)</p>	Operation (Drainage)	Drop	
<p>The operation time with the timer will be approx. 1 minute.</p> <p>* If the water surface touches to the electrode for more than one (1) second within 1 minute, the pump operates continuously even though the timer is on.</p> 	Operation (Drainage)	Drop	
<p>After 1 minute, the pump will stop.</p> <p>* If the water is drained within 1 minute, the pump continues to run in snore mode until the set time comes.</p> 	Stop	Rise	
<p>When the water level rises and the water surface touches to the electrode again for more than one (1) second, pump will restart.</p>  <p>(Detection Time : more than one (1) second)</p>	Start operation (Drainage)	Drop	



# 7 MAINTENANCE AND INSPECTION

Regular maintenance and inspections are a necessity for continued efficient functioning of the pump. If any abnormal conditions are noticed, refer to the section "9.Troubleshooting" and take corrective measures immediately. It is recommended that a spare pump be kept ready in case of any problems.

## Prior to inspection



**WARNING** Detach the cabtyre cable from the receptacle or terminals, after making certain the power supply (circuit breaker, etc.) is turned off. Failure to follow this precaution may result in a serious accident from electrical shock or unexpected starting of the pump motor.

- (1) Washing the pump  
Remove accumulated matter from the surface of the pump and wash it with clean water. Take special care to remove any debris from the impeller.
- (2) Inspecting the pump exterior  
Look for any peeling or chipped paint, and make sure the nuts and bolts are fastened tightly. Any cracks in the surface should be repaired by cleaning that area, drying it and then applying a touchup coating.

**Note:** *Touchup is not supplied. Note that some kinds of damage or looseness may require that the unit be disassembled for repairs. Please consult with your nearest dealer or Tsurumi representative.*

## Regular Inspection

Frequency	Inspection Items
Daily	<ul style="list-style-type: none"> <li>■ Measuring the operating current ● To be below the rated current</li> <li>■ Measuring the power voltage ● Power supply voltage tolerance = within <math>\pm 5\%</math> of the rated voltage</li> </ul>
Monthly	<ul style="list-style-type: none"> <li>■ Measure insulation resistance ● Reference insulation resistance = 1M<math>\Omega</math> or greater <i>Note: If the insulation resistance has become notably lower than the previous inspection, an inspection of the motor will be necessary.</i></li> <li>■ Pump inspection ● A noticeable drop in performance may indicate wear in the impeller etc., or else clogging of the strainer stand, etc. Remove the clogged debris, and replace any worn parts.</li> <li>■ Inspecting the electrode ● Clean the electrode periodically with an abrasive paper or the like.</li> </ul>
Semi-annually	<ul style="list-style-type: none"> <li>■ Oil inspection ● Check the oil every six months or after 3,000 hours of use, whichever comes first.</li> <li>■ Inspection of lifting wire rope or chain ● Replace if damage, corrosion, or wear has occurred to the wire rope or the chain. Remove if foreign object is attaching to it.</li> </ul>
Annually	<ul style="list-style-type: none"> <li>■ Change oil ● Change the oil every 12 months or after 6,000 hours of use, whichever comes first. Designated oil : Turbine oil VG32 <i>Note: See below for details of oil inspection and oil change.</i></li> <li>■ Change mechanical seal <i>Note: Specialized know-how is required for inspecting and replacing the mechanical seal. Consult with your nearest dealer or Tsurumi representative.</i></li> </ul>
Every 2 to 5 years	<ul style="list-style-type: none"> <li>■ Overhaul ● This should be carried out even if there are no problems with the pump. The frequency depends on how continuously the pump is in use. <i>Note: Consult with your nearest dealer or Tsurumi representative regarding overhauls.</i></li> </ul>

## Storage

When the pump is out of use for an extended period, wash it and dry it thoroughly, then store it indoors. If the pump is left in the water, it should be run at a minimum of once a week to prevent it from locking up.

**Note:** *Always run a test operation before putting the pump back into service.*

## Oil inspection and Oil change

### Inspecting oil

Remove the oil plug (hex. bolt) and tilt the pump to drain a small amount of oil. If the oil is milky white or has water mixed in with it, the mechanical seal may be faulty. In this case the pump will need to be disassembled and repaired.

### Replacing oil

Remove the oil plug and drain all the oil, then replace it with the specified amount.

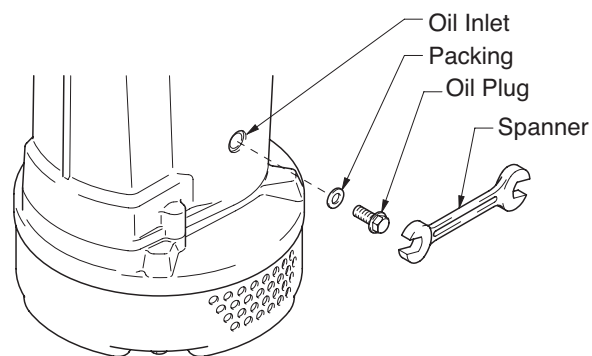

**Note:** *Worn oil and other waste products should be disposed of by a qualified agent, in accord with applicable laws. The oil plug packing should be replaced each time the oil is inspected or changed.*

Specified Oil : Turbine Oil VG32 (non-additive) Unit : ml

Applicable Model	Specified Volume
KTV2-8, KTVE2.75	150
KTV2-15, KTV2-22, KTVE21.5, KTVE22.2	270
KTV2-37H, KTV2-37, KTVE33.7	400
KTV3-55 *, KTVE35.5	680
NK3-15, NK4-22	270
NK3-22L	580

\* USA market: KTV2-55

## Replacement Parts

The table lists the parts that need to be replaced periodically. Replace these using the recommended frequency as a guideline.

Part	Replacement frequency
Mechanical Seal	When oil in oil compartment becomes milky.
Lubricant ; Turbine Oil VG32 (non-additive)	Every 6,000 hours or 12 month, whichever comes first.
Packing, O-Ring	Each time pump is disassembled or inspected.
V-Ring	When ring is worn, and each time pump is disassembled or inspected
Shaft sleeve	When it becomes worn

 **WARNING**

- Before disassembling the pump, first detach the Cabtyre Cable from the receptacle or terminals, after making certain the power supply (circuit breaker, etc.) is turned off. To avoid electrical shock, do not work with wet hands. Never check the operation of any parts (impeller rotation, etc.) by turning on the power while the unit is partially assembled. Failure to observe these precautions may result in serious accident.
- Do not disassemble or repair any parts other than those designated here. If repairs are necessary in any other than the designated parts, consult with your nearest dealer or Tsurumi representative. Improper repairs can result in electrical leakage, electrical shock, fire, or water leaks.
- After reassembly, always perform a test operation before resuming use of the pump. Improper assembly will cause the pump to malfunction, resulting in electrical shock or water leaks.

The procedure for disassembly and reassembly is shown here to the extent necessary for impeller replacement. A specialized environment and facilities are necessary for work in the mechanical seal and motor parts. Contact your nearest dealer or Tsurumi representative in the event such repairs are necessary.

 **Disassembly**

**Note:** *Remove the oil prior to disassembly.*

- (1) Removing the Strainer Stand, Fixing Plate and Pump Casing  
Remove the Strainer Stand Hex. Bolts and Plain Washers, then remove the Strainer Stand, Fixing Plate and Pump Casing from the pump.
- (2) Removing the Impeller  
With a socket wrench or other tool, loosen the Impeller Nut and Hex. Nuts, remove the Plain Washer and key, then remove the Impeller, Shaft Sleeve and V-Ring from the Shaft.
- (3) Removing the Rear Liner  
Remove the Rear Liner from the Oil Casing.



**WARNING** A worn Impeller may have sharp edges that can cause injury, and should be handled with care.

# Disassembly Diagram

## Example 1 - Model KTV2-22

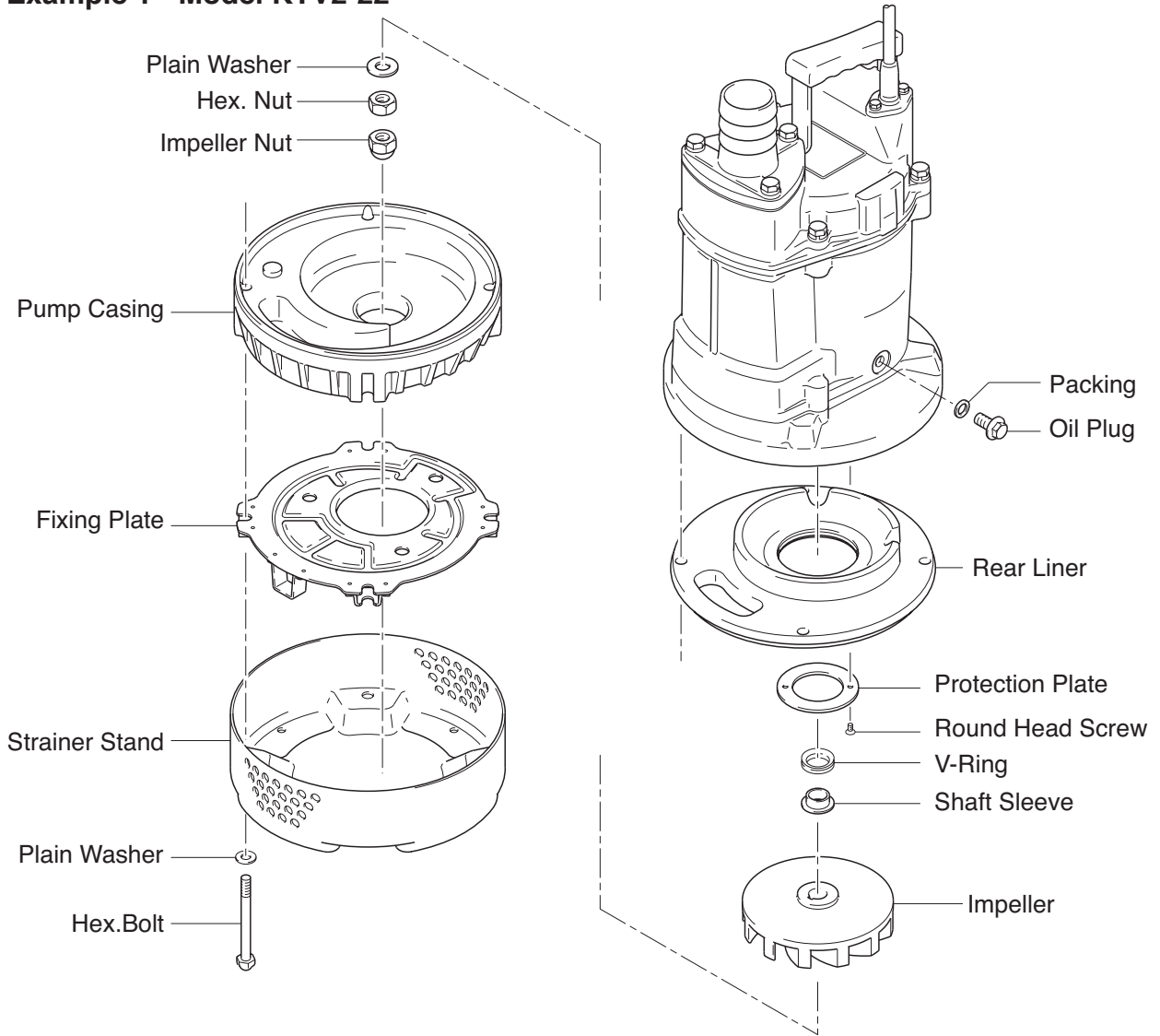

## ■ Example 2 - Model NK4-22

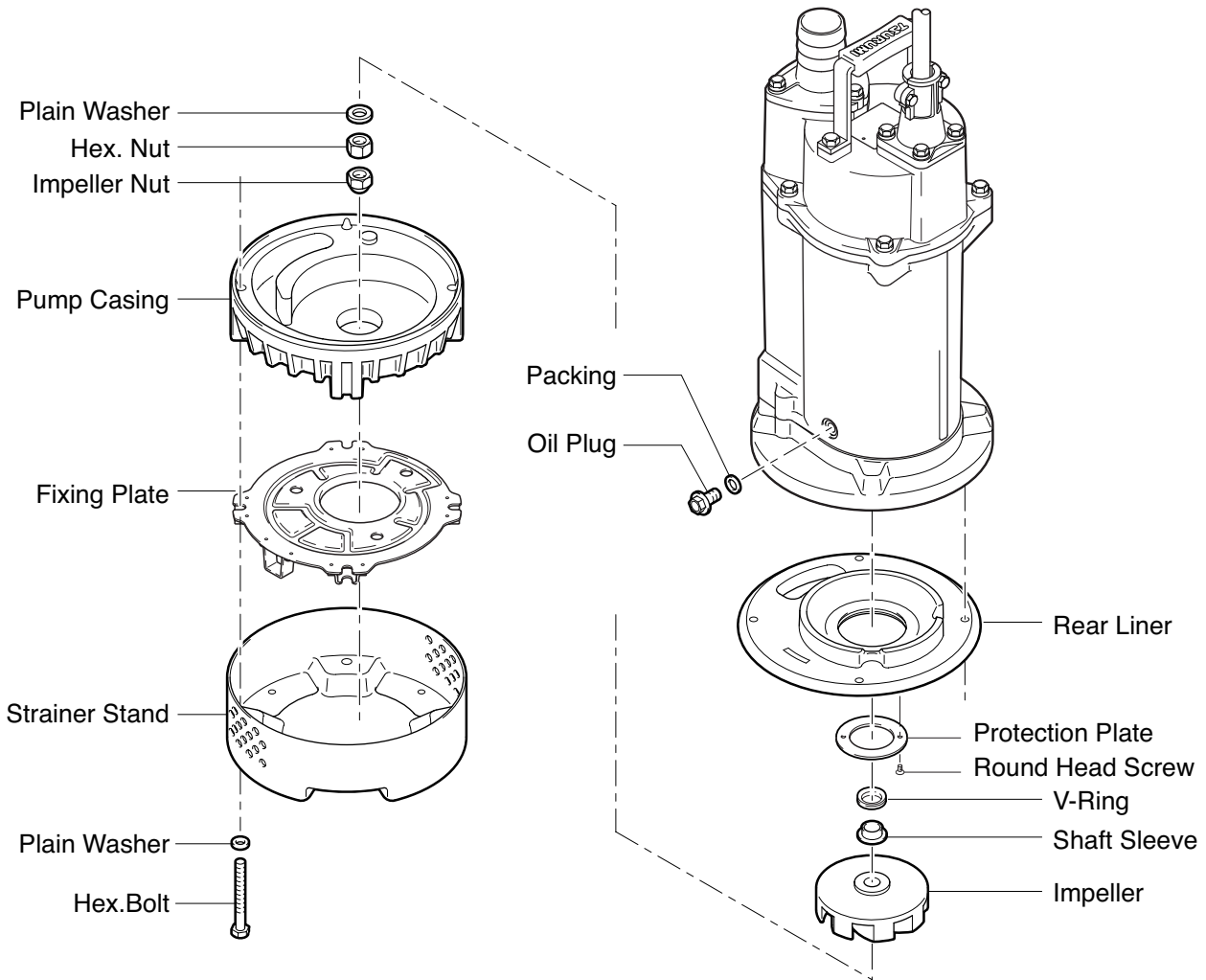

**Note:** *The above exploded views are for model KTV2-22 and NK3-22. Other models may differ slightly in shape and construction.*

## ▀ Reassembly

- (1) Reassembly can be performed by reversing the steps for disassembly, paying attention to the following precautions.

**Note:**

- After assembling the pump, do not forget to fill it with oil up to the required amount.
- Replace the Packing and O-Ring each time this operation is performed. Replace any other parts worn or damaged as well.

**Note:** *Mount the V-Ring on the outside of the Shaft Sleeve as shown in right. Never put oil on the mating surface between the Shaft Sleeve and the V-Ring.*

- (2) After installing the Impeller, and after completing the reassembly, check to make sure that the impeller rotates smoothly and that it does not rub against any part of the Pump Casing.

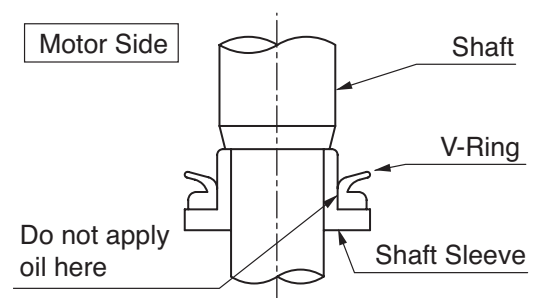

## 9 TROUBLESHOOTING

**⚠ WARNING** Always turn off the power before inspecting the pump. Failure to observe this precaution can result in serious accident.

Before ordering repairs, carefully read through this instruction manual, then repeat the inspection. If the problem remains, contact your nearest dealer or Tsurumi representative.

Problem	Possible causes	Countermeasure
Pump will not start	(1)Power is off. (2)Cable is cut or not connected properly. (3)Impeller is clogged. (4)Obstructed conductivity. (5)Short circuit between electrode and the body by fouling object. (6)Being subjected to nearby electric apparatus.	(1)Turn power on. (2)Repair/replace the cable or fix the connection. (3)Inspect the pump and remove any debris. (4)Clean the electrode. (5)Remove the object that causes short circuit. (6)Relocate if it is found to be true.
Pump stops soon after starting (Motor protector operates)	(1)Impeller is clogged. (2)Low voltage. (3)Wrong power frequency. (4)Extended operation with a clogged strainer stand. (5)Faulty motor (burning, water infiltration, etc.). (6)Motor protection system was triggered.	(1)Remove debris. (2)Provide the rated voltage, or make sure the cable extension is the proper standard. (3)Check the name plate, and replace the pump. (4)Remove debris from the strainer stand. (5)Repair or replace the motor. (6)If the pump is to be used for heavy liquid or other high loads, upgrade impeller.
Poor pumping head or discharge capacity	(1)Worn out impeller or suction cover. (2)Sharply bent or clogged hose. (3)Strainer stand clogged or buried. (4)Motor direction is reversed. (5)Wrong power frequency.	(1)Repair or replace the worn parts. (2)Straighten out any sharp bends. Enclose the pump with a screen to keep away debris. (3)Remove debris from the strainer stand, or place a block under the pump. (4)Interchange power supply leads as per p.10. (5)Check the name plate, and replace the pump.
Heavy vibration or noise	(1)Damaged motor shaft.	(1)Contact dealer and replace motor.

### Disposal Product

Properly dispose of the product by disassembling it, presorting the contents, and sending them to the waste material treatment site.

The following information is required when ordering repairs or making other inquiries.

Product model	
Manufacturing number	
Purchase date	
Remarks	